

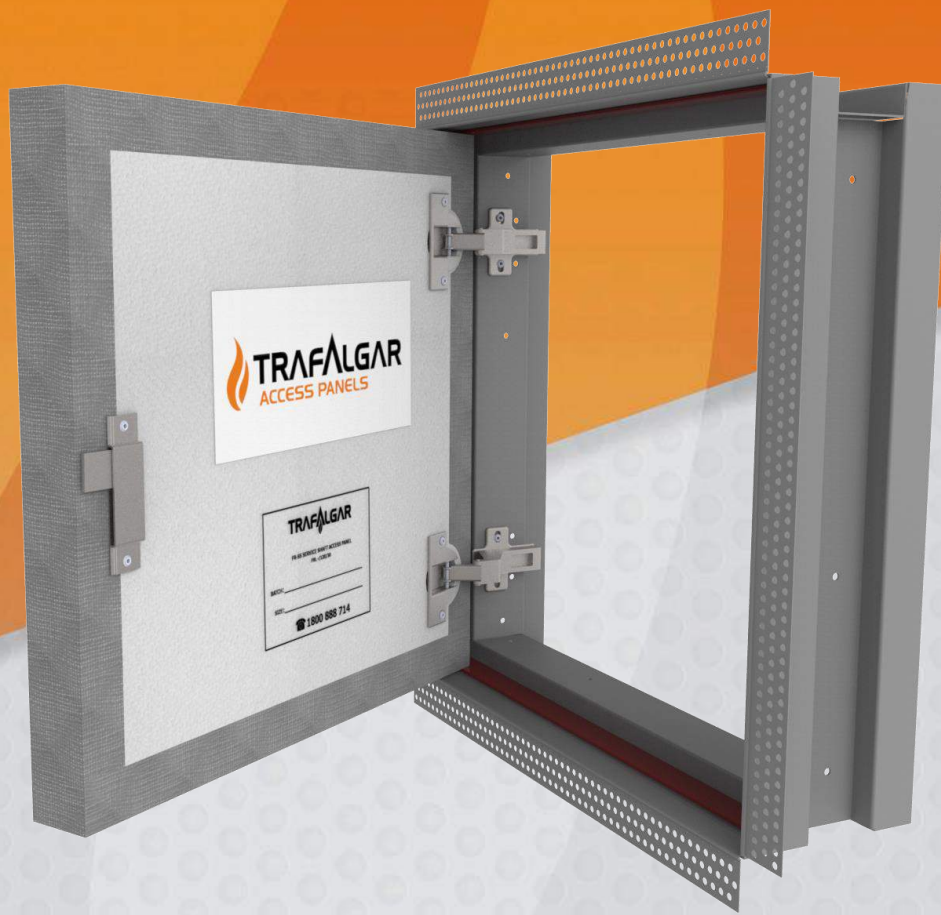

FIRE RATED

WALL ACCESS PANELS (FRW)



Trafalgar has the most extensive range of access panels available:

Small Sizes | Large Sizes | Custom Sizes
Tileable | Security | Acoustic | Fire Rated
Stainless Steel | Upward Opening | MDF
Touch Latch | Customwood | Service Shaft

taccess.com.au

FIRE RATED

Wall Access Panels (FRW)

Product Overview

Trafalgar Fire Rated Wall Access Panels are manufactured in Australia and have been designed for use where access is required into fire rated walls. They feature concealed hinges and provide lockable access to services. Trafalgar FRW panels have been fire tested to Australian Standard AS1530.4 and have attained up to a two hour fire rating for walls and service shafts.



Trafalgar manufacture and supply a two hour fire rated wall access panel with concealed hinges and a key lock option.

Trafalgar Fire Rated Wall Panels are available with fire ratings of one or two hours. When installed they sit flush with the surface leaving a neat opening around the perimeter. These panels are secured with an allen key style lock as standard, however a key lock option is also available.

It is easier to design and order standard sizes as these are readily available and competitively priced. However, other sizes can be manufactured to order.

Access panels are typically installed during construction, but they can also be retro-fitted when additional access is required.

Trafalgar specialise in manufacturing large custom size access panels with varying hinge and lock options to meet architectural specifications.

FIRE RATED

Wall Access Panels (FRW)

Technical Specifications

PRODUCT DESCRIPTION

FIRE RATING 1 Hour -/60/60
2 Hour -/120/60

Door Panel Paint grade Trafalgar panel incorporating Maxilite high performance fire rated board.

Frame Fully welded, fully primed steel.

Cut-Out Size Cut out a hole in the wall the same size as the access panel. For example, a 450x450 access panel will have a 450x450 cut out.

With Trafalgar FRW panels there is no need to line the inside of opening with fire rated plasterboard.

Frame Types Flanged Edge (FE) or Wet Wall (WW)

Hinge Fully concealed hinges.

Lock Budget square key lock as standard (Allen key style lock).

Key lock options available.

Also Available Trafalgar can custom manufacture to meet your specifications. Trafalgar also supply a comprehensive range of metal, acoustic, customwood, security and speciality access panels.

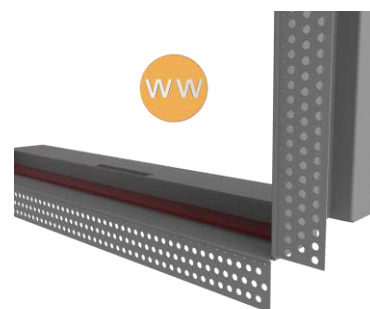

Wet Wall Frame
(Set bead for plastering in)

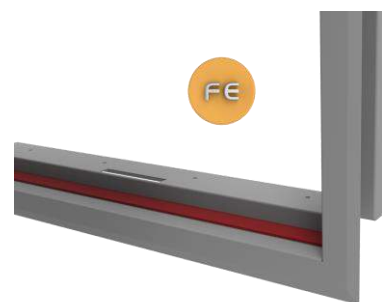

Flanged Edge Frame
(Architrave / picture frame)

FIRE RATED

Wall Access Panels (FRW)

Ordering Information

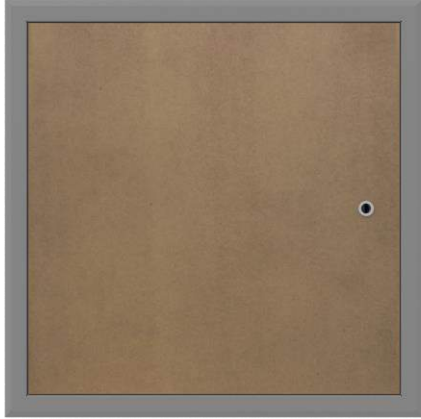

1 HOUR FRW PANELS

- Feature fully concealed hinges.
- Key lock option available.
- Designed for use in fire rated walls.
- Easy installation. Trimming of opening not required.

1 HOUR FIRE RATED WALL ACCESS PANELS

Code	Size (mm)	Panel	Fire Rating	Frame
<u>STOCK SIZES</u>				
FRW1-300-FE	300 x 300	Maxilite Fire Rated Board	1 hour -/60/60	Flanged Edge (Architrave)
FRW1-400-FE	400 x 400			
FRW1-450-FE	450 x 450			
FRW1-6040-FE	600 x 400			
FRW1-600-FE	600 x 600			
<u>CUSTOM SIZES</u>				
FRW1-Custom-FE	Any size up to 1000 x 600			
<u>STOCK SIZES</u>				
FRW1-300-WW	300 x 300	Maxilite Fire Rated Board	1 hour -/60/60	Wet Wall (Set bead to plaster in)
FRW1-400-WW	400 x 400			
FRW1-450-WW	450 x 450			
FRW1-6040-WW	600 x 400			
FRW1-600-WW	600 x 600			
<u>CUSTOM SIZES</u>				
FRW1-Custom-WW	Any size up to 1000 x 600			

NOTE: For sizes above 1000x600mm please refer to Trafalgar's Fire Rated Service Shaft datasheet.

Trafalgar Fire Rated Wall Access Panels must be installed into the openings in walls or shafts in positions indicated on the architectural drawings, and in accordance with Trafalgar's installation instructions.

FIRE RATED

Wall Access Panels (FRW)

Ordering Information

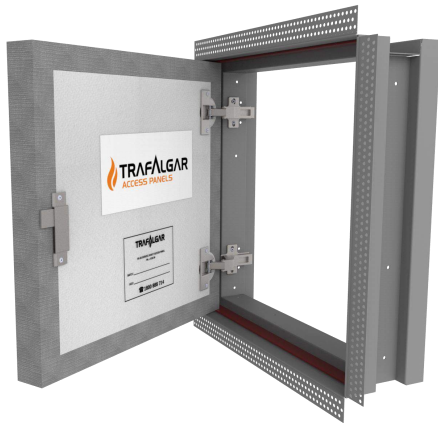

2 HOUR FRW PANELS

- Feature fully concealed hinges.
- Key lock option available.
- Designed for use in fire rated walls.
- Easy installation. Trimming of opening not required.

2 HOUR FIRE RATED WALL ACCESS PANELS

Code	Size (mm)	Panel	Fire Rating	Frame
<u>STOCK SIZES</u>				
FRW2-300-FE	300 x 300	Maxilite Fire Rated Board	2 hour -/120/60	Flanged Edge (Architrave)
FRW2-400-FE	400 x 400			
FRW2-450-FE	450 x 450			
FRW2-6040-FE	600 x 400			
FRW2-600-FE	600 x 600			
<u>CUSTOM SIZES</u>				
FRW2-Custom-FE	Any size up to 1000 x 600			
<u>STOCK SIZES</u>				
FRW2-300-WW	300 x 300	Maxilite Fire Rated Board	2 hour -/120/60	Wet Wall (Set bead to plaster in)
FRW2-400-WW	400 x 400			
FRW2-450-WW	450 x 450			
FRW2-6040-WW	600 x 400			
FRW2-600-WW	600 x 600			
<u>CUSTOM SIZES</u>				
FRW2-Custom-WW	Any size up to 1000 x 600			

NOTE: For sizes above 1000x600mm please refer to Trafalgar's Fire Rated Service Shaft datasheet.

Trafalgar Fire Rated Wall Access Panels must be installed into the openings in walls or shafts in positions indicated on the architectural drawings, and in accordance with Trafalgar's installation instructions.

FIRE RATED

Wall Access Panels (FRW)

Installation Instructions

FRW - Profile Details

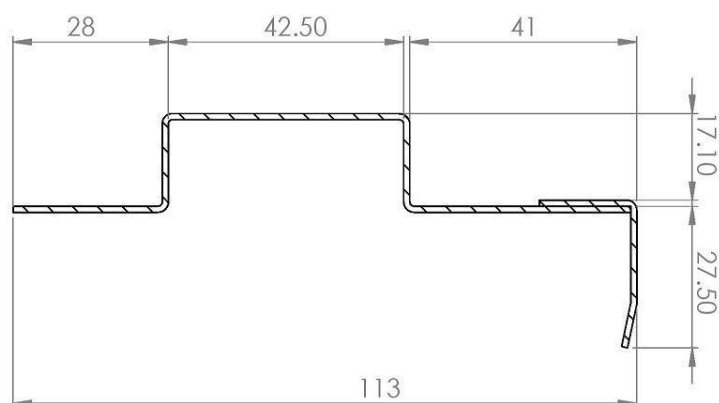

Access Panel	Use	Construction	Fixings	Fixing Type	Max Fixing Centres
FRW	Wall	Plasterboard	8 gauge	Self-tapping	150mm
FRW	Wall	Masonry	M6	Masonry Anchor	350mm

Installation Instructions

1. Mark out and cut an opening in the ceiling or wall to suit the dimensions of the access panel (eg. 450 x 450), taking into account the position of existing joists. Note that for plasterboard installs, no fire rated plasterboard lining is required.
2. With the hatch of the access panel open, insert the panel into position and fix through the fixing holes in the frame into the surrounding framework, with fixings as detailed in the table above and see drawings below (next page).

NOTE:

- The installation of Trafalgar Fire Rated Access Panels does not require fire rated sealant.
- Trafalgar Fire Rated Access Panels have been fire tested to the new and more stringent requirements of Australian Standard AS1530.4-2005.

FIRE RATED

Wall Access Panels (FRW)

Installation Instructions

FRW - Plasterboard Install

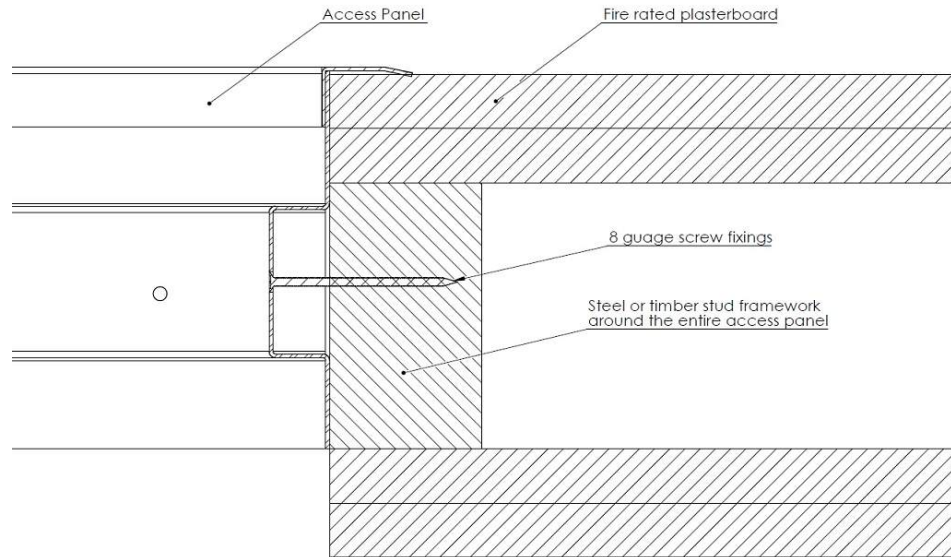

FRW - Masonry Install

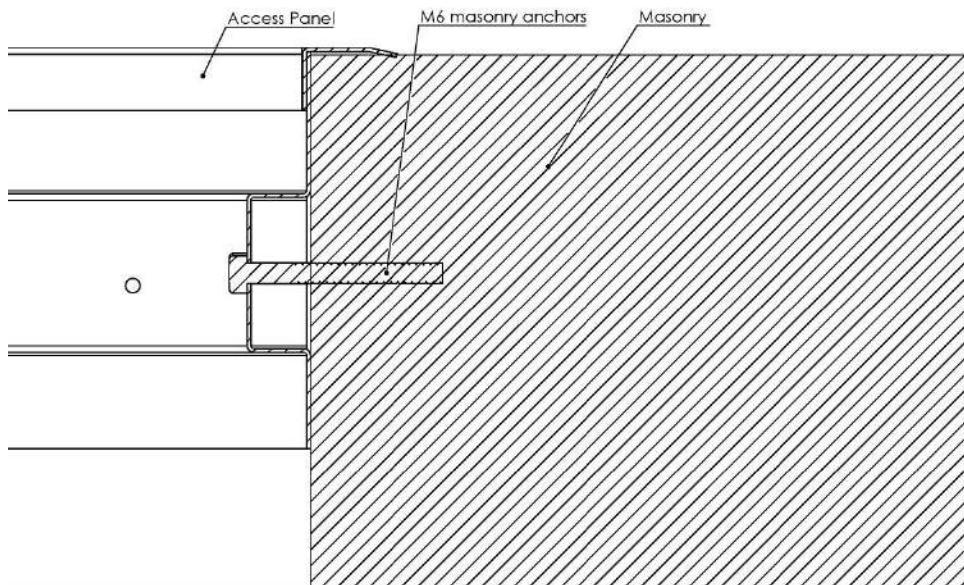

Trafalgar has developed a range of **installation videos** to assist our customers. To view these step by step install videos please go to www.youtube.com and search for **Trafalgar TV**. Subscribe and you will be notified when new videos are uploaded.

Trafalgar reserves the right to change specifications without notice. Please check with your supplier at the time of order. The information contained in this brochure was correct at the time of print. E&OE. Published 01.09.15